

EXPLODED VIEW

KL 130.11.062

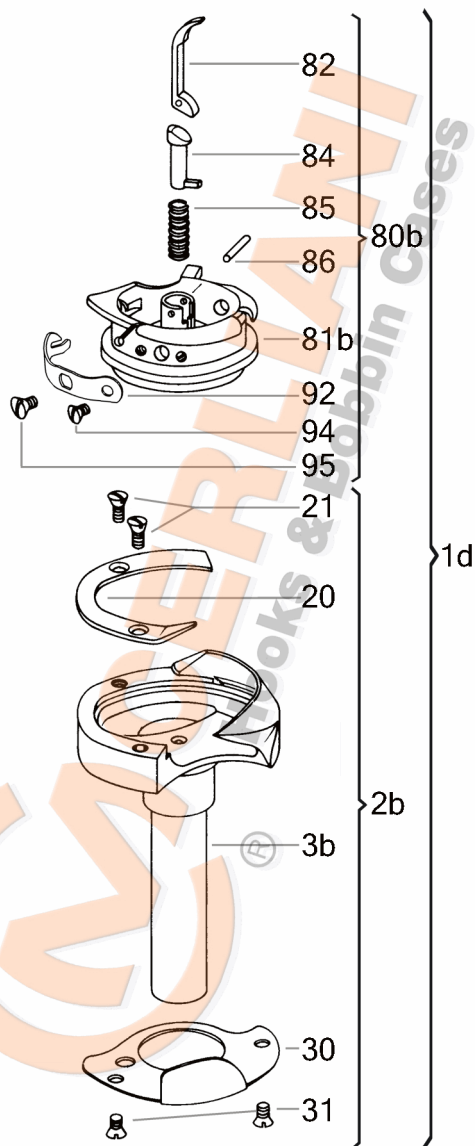

Attention: The graphic representation shows only the typology of the components of the article and does not correspond to the real part.

No	CERLIANI ARTICLE	DESCRIPTION
1d	130.11.062	HOOK COMPLETE
2b	130.11.063	HOOK WITHOUT BASKET
20	130.11.019	HOOK GIB
21	130.11.004	HOOK GIB FASTENING SCREW
30	130.11.081	NEEDLE GUARD
31	130.11.049	NEEDLE GUARD FASTENING SCREW
80b	130.11.025	COMPLETE BASKET
81b	130.11.026	BASKET BODY
82	130.11.012	LEVER
84	130.11.011	BOBBIN EJECTOR
85	130.11.014	SPIRAL SPRING OF LEVER
86	130.08.012	LEVER'S PIN
92	130.11.027	TENSION SPRING
94	130.11.020	TENSION SPRING FAST. SCREW
95	130.11.037	TENSION SPRING ADJ. SCREW

This document and the information enclosed are intellectual property of CM CERLIANI and may not be rebroadcast in any form without express permission from CM CERLIANI. If you want to use any of these information for any use other than personal use, please contact CM CERLIANI to get the permission.