

EXPLODED VIEW

KK 130.08.904

Attention: The graphic representation shows only the typology of the components of the article and does not correspond to the real part.

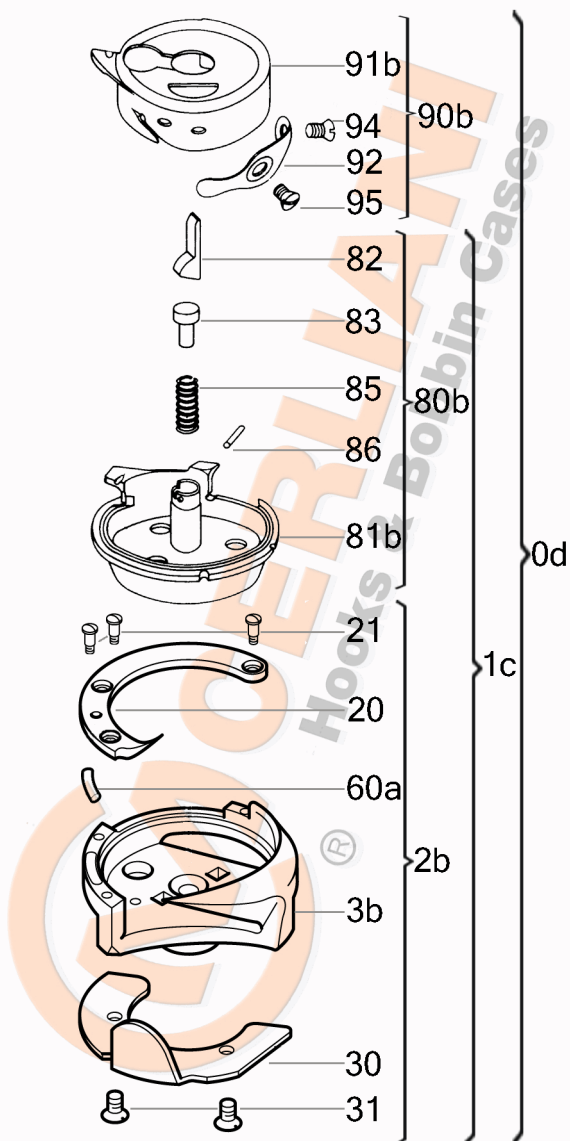

No	CERLIANI ARTICLE	DESCRIPTION
0d	130.08.904	HOOK WITH CAP
1c	130.08.905	HOOK WITHOUT CAP
2b	130.08.906	HOOK WITHOUT BASKET
20	130.08.046	HOOK GIB
21	130.08.005	HOOK GIB FASTENING SCREW
26	130.08.355	THREAD GUARD FASTENING SCREW
30	130.08.323	NEEDLE GUARD
60a	130.08.024	LUBRICATION FELT (UNDER GIB)
80b	130.08.008	COMPLETE BASKET
82	130.08.010	LEVER
83	130.08.011	PISTON
85	130.08.013	SPIRAL SPRING OF LEVER
86	130.08.012	LEVER'S PIN
90b	130.08.014	CAP
92	130.08.016	TENSION SPRING
94	130.06.104	TENSION SPRING FAST. SCREW
95	130.08.018	TENSION SPRING ADJ. SCREW

This document and the information enclosed are intellectual property of CM CERLIANI and may not be rebroadcast in any form without express permission from CM CERLIANI. If you want to use any of these information for any use other than personal use, please contact CM CERLIANI to get the permission.