

EXPLODED VIEW

KK 130.08.180

Attention: The graphic representation shows only the typology of the components of the article and does not correspond to the real part.

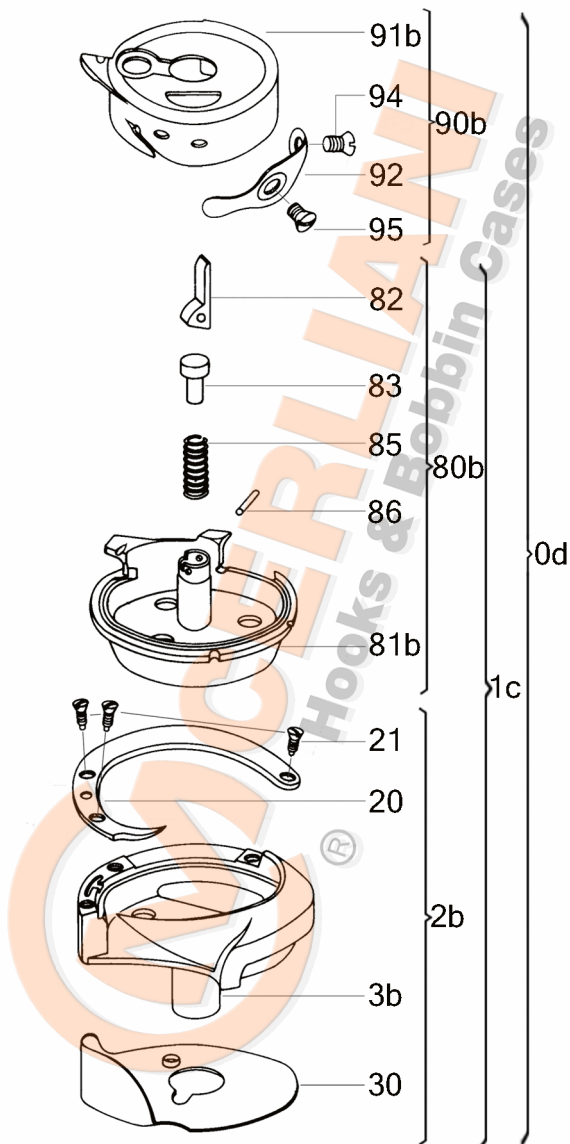

No	CERLIANI ARTICLE	DESCRIPTION
0d	130.08.180	HOOK WITH CAP
1c	130.08.181	HOOK WITHOUT CAP
2b	130.08.170	HOOK WITHOUT BASKET
20	130.08.123	HOOK GIB
21	130.08.005	HOOK GIB FASTENING SCREW
30	130.08.105	NEEDLE GUARD
60a	130.08.024	LUBRICATION FELT (UNDER GIB)
80b	130.08.176	COMPLETE BASKET
82	130.08.010	LEVER
83	130.08.011	PISTON
86	130.08.012	LEVER'S PIN
90b	130.08.135	CAP
92	130.08.111	TENSION SPRING
94	130.06.104	TENSION SPRING FAST. SCREW
95	130.08.018	TENSION SPRING ADJ. SCREW
98	130.08.013	SPIRAL SPRING OF LATCH

This document and the information enclosed are intellectual property of CM CERLIANI and may not be rebroadcast in any form without express permission from CM CERLIANI. If you want to use any of these information for any use other than personal use, please contact CM CERLIANI to get the permission.