

EXPLODED VIEW

KH 130.09.223

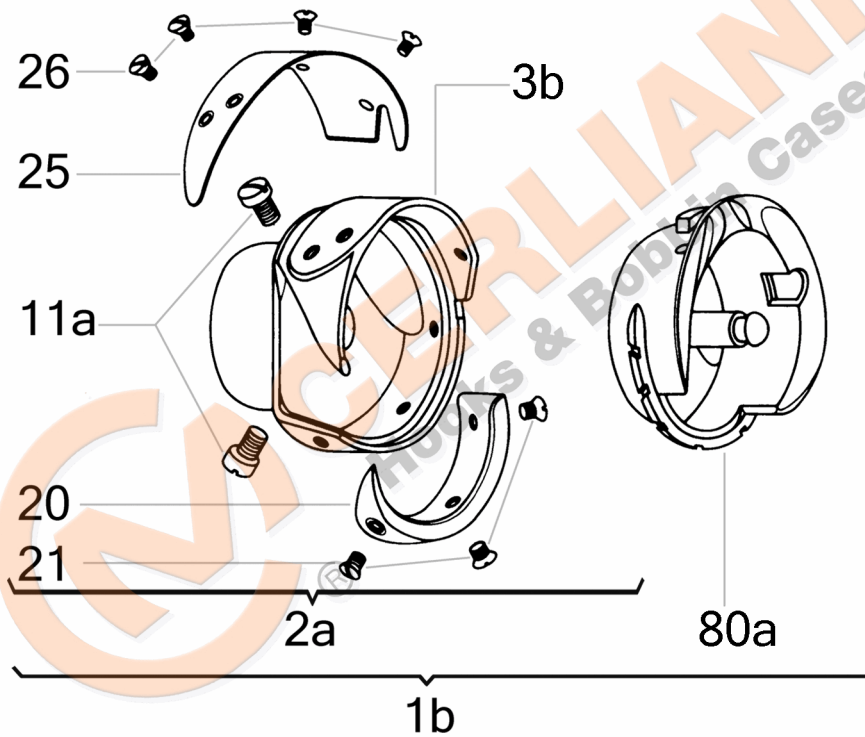

Attention: The graphic representation shows only the typology of the components of the article and does not correspond to the real part.

No	CERLIANI ARTICLE	DESCRIPTION
1b	130.09.223	HOOK WITHOUT BOBBIN CASE
2a	130.09.224	HOOK WITHOUT BOBBINCASE HOLDER
3b	130.09.225	HOOK BODY
11a	120.00.029	HOOK FASTENING SCREW
20	130.09.119	HOOK GIB
21	130.09.017	HOOK GIB FASTENING SCREW
25	130.09.132	THREAD GUARD
26	130.01.005	THREAD GUARD FASTENING SCREW
80a	130.09.118	BOBBIN CASE HOLDER

This document and the information enclosed are intellectual property of CM CERLIANI and may not be rebroadcast in any form without express permission from CM CERLIANI. If you want to use any of these information for any use other than personal use, please contact CM CERLIANI to get the permission.