

EXPLODED VIEW

KH 130.05.543

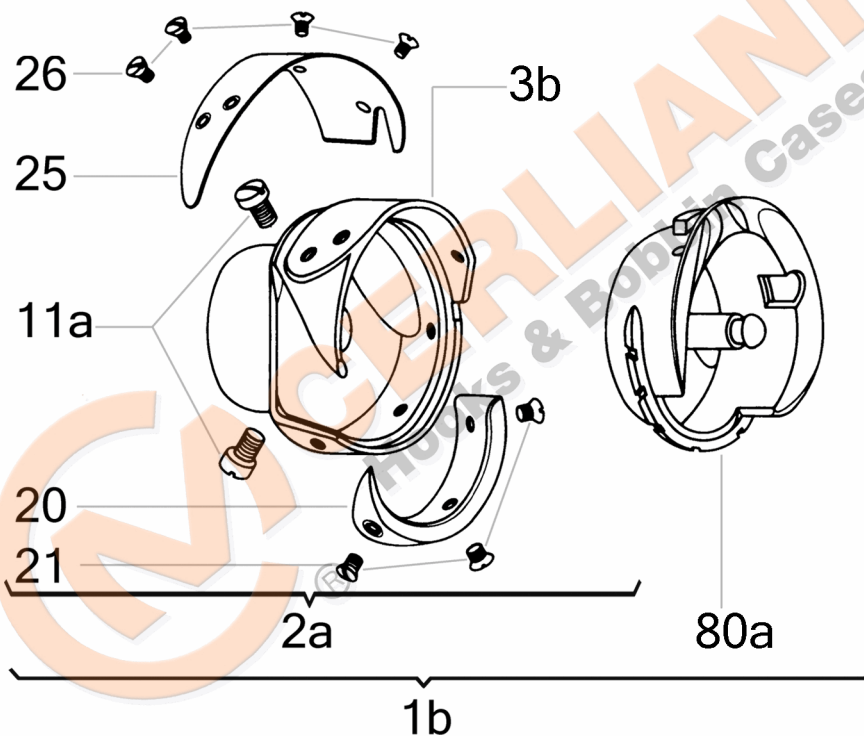

Attention: The graphic representation shows only the typology of the components of the article and does not correspond to the real part.

No	CERLIANI ARTICLE	DESCRIPTION
1b	130.05.543	HOOK WITHOUT BOBBIN CASE
2a	130.05.544	HOOK WITHOUT BOBBINCASE HOLDER
3b	130.05.438	HOOK BODY
11a	120.00.029	HOOK FASTENING SCREW
11b	120.00.040	HOOK FASTENING GRUB SCREW
20	130.05.238	HOOK GIB
21	130.01.003	HOOK GIB FASTENING SCREW
25	130.05.504	THREAD GUARD
26	130.01.005	THREAD GUARD FASTENING SCREW
68	130.05.123	CENTRAL HOLE PLUG DISC
70	130.05.104	LUBRIFICATION PLUG PIN
80a	130.05.429	BOBBIN CASE HOLDER

This document and the information enclosed are intellectual property of CM CERLIANI and may not be rebroadcast in any form without express permission from CM CERLIANI. If you want to use any of these information for any use other than personal use, please contact CM CERLIANI to get the permission.