

EXPLODED VIEW

KH 130.05.517

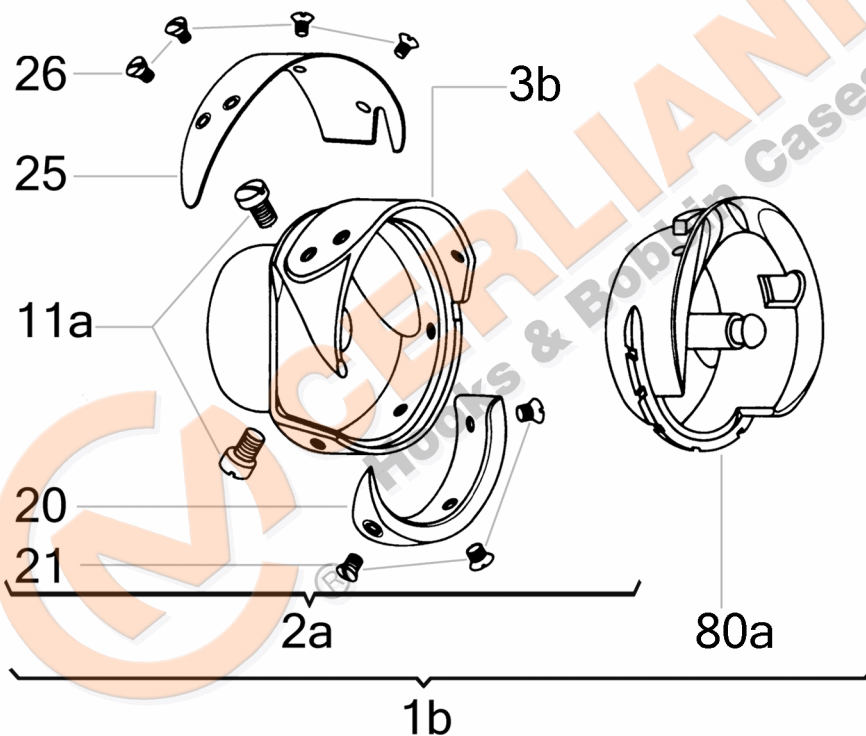

Attention: The graphic representation shows only the typology of the components of the article and does not correspond to the real part.

No	CERLIANI ARTICLE	DESCRIPTION
1b	130.05.517	HOOK WITHOUT BOBBIN CASE
2a	130.05.518	HOOK WITHOUT BOBBINCASE HOLDER
3b	130.05.519	HOOK BODY
11a	120.00.029	HOOK FASTENING SCREW
11b	120.00.040	HOOK FASTENING GRUB SCREW
20	130.01.411	HOOK GIB
21	130.01.003	HOOK GIB FASTENING SCREW
25	130.05.523	THREAD GUARD
26	130.01.005	THREAD GUARD FASTENING SCREW
68	130.05.123	CENTRAL HOLE PLUG DISC
70	130.05.104	LUBRIFICATION PLUG PIN
80a	130.05.520	BOBBIN CASE HOLDER

This document and the information enclosed are intellectual property of CM CERLIANI and may not be rebroadcast in any form without express permission from CM CERLIANI. If you want to use any of these information for any use other than personal use, please contact CM CERLIANI to get the permission.